

Figure 253

### Crimped-On Leads, Figure 253

A high temperature double crimp connects the MGT (450°C) leads to solid nickel pins. This construction is recommended for applications with elevated temperatures. Due to the rigid nickel pins, this construction is not recommended in applications where movement or flexing is encountered, or if sharp bends are required adjacent to the heater exit

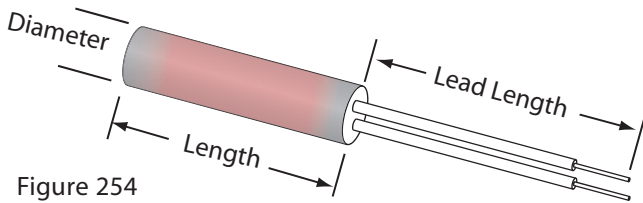

Figure 254

### Swaged in Leads, Figure 254

High temperature MGT (450°C) wire is internally connected and swaged in place. This construction is recommended for applications in which the leads must be bent at the exit point from the heater and where mild flexing may be found. For applications with continuous or more severe movement, we would recommend metal braid or armor cable.

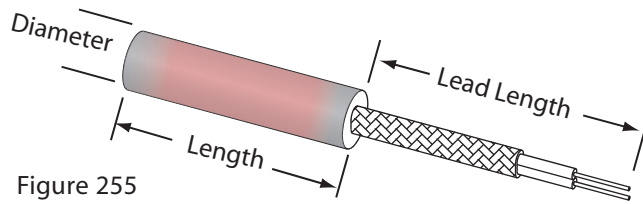

Figure 255

### Stainless Steel Braid, Figure 255

High temperature MGT (450°C) wire is internally connected and swaged in place along with stainless steel braid. This construction offers protection against abrasion and sharp edges. This is a very strong construction which offers full length flexibility. This construction is recommended in applications with flexing and where the leads must pass through metal openings or routed along metal components.

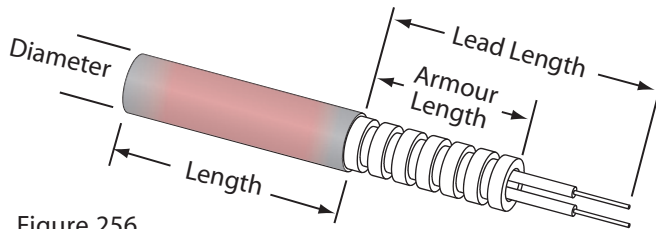

Figure 256

### Stainless Steel Armoured Cable (Hose), Figure 256

High temperature MGT (450°C) wire is internally connected and swaged in place along with stainless steel hose. This construction is recommended for applications in which the leads are subjected to abrasion or run the risk of being pinched. This is the strongest lead protection available and works well in moving or flexing applications.

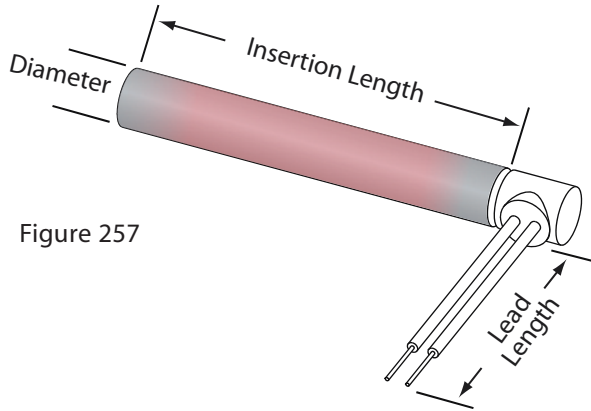

Figure 257

### Right Angle Fibreglass Leads, Figure 257

High temperature MGT (450°C) leads exiting at right angle to the sheath. This construction offers a compact design where space is limited. This construction is not recommended where abrasion or flexing is present.

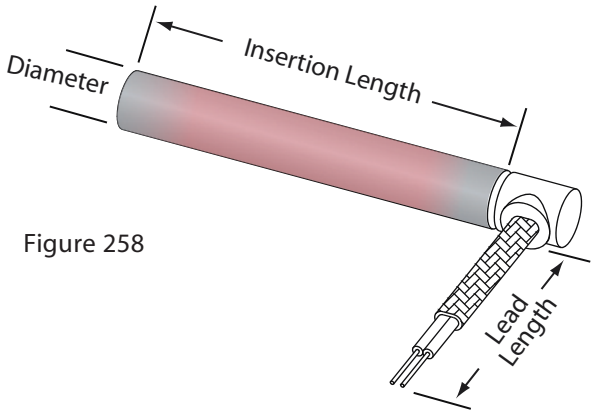

Figure 258

### Right Angle Stainless Steel Braid, Figure 258

Stainless steel braid over high temperature MGT (450°C) wire exiting at right angle to the sheath. This construction is recommended in applications with flexing and where the leads must pass through metal openings or routed along metal components. This construction is desirable when space is limited and it is not feasible to bend standard leads.

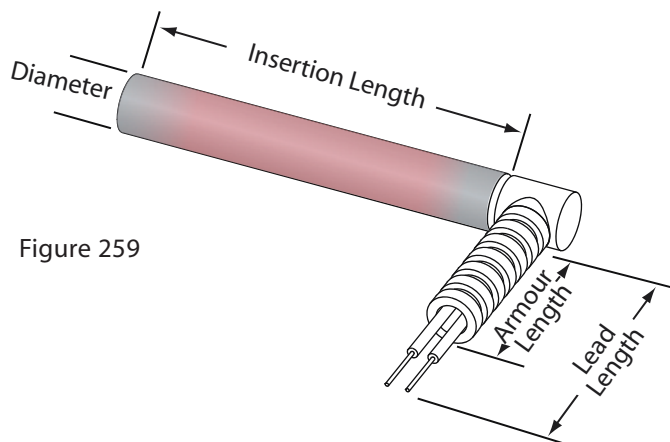

Figure 259

### Right Angle Stainless Steel Armour (Hose), Figure 259

Stainless steel hose over high temperature MGT (450°C) wire exiting at right angle to the sheath. This is the strongest lead protection for use in applications where severe abrasion is present. These leads offer good flexibility and are good for moving or flexing applications.

| Heater Diameter | Minimum Unheated Length |
|-----------------|-------------------------|
| 1/8"            | Not Available           |
| 1/4"            | 1"                      |
| 5/16"           | 1 1/2"                  |
| 3/8"            | 1 1/2"                  |
| 1/2"            | 1 1/2"                  |
| 5/8"            | 1 9/16"                 |
| 3/4"            | 1 7/8"                  |
| 15/16"          | 1 7/8"                  |
| 1"              | 1 7/8"                  |

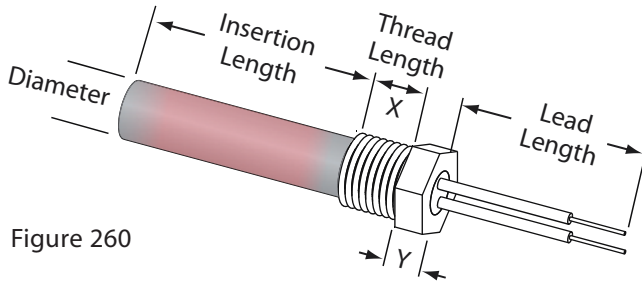

Figure 260

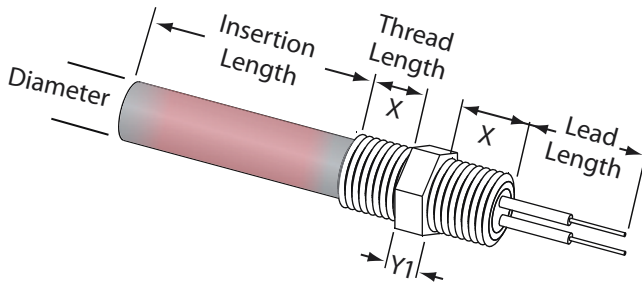

Figure 261

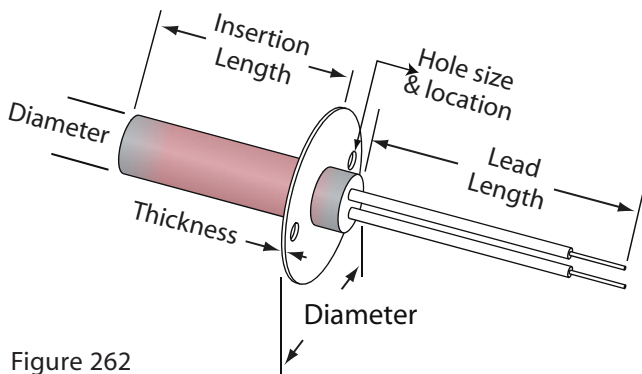

Figure 262

### Single and Double Threaded Fittings, Figures 260 & 261

Single or double threaded fittings attached to sheath to allow for installation into threaded holes.

**Fitting Materials** - Brass, Steel and Stainless Steel

**Leadwires** - Fiberglass for high temperature applications  
 - Teflon for moisture protection  
 - Stainless Braid or Hose for flexing applications and abrasion protection

**Terminal Boxes** - General purpose and moisture resistant housings

| Heater Diameter | NPT Size     | X Dimension | Y Dimension | Y1 Dimension |
|-----------------|--------------|-------------|-------------|--------------|
| 1/4"            | 1/8-27       | 3/8"        | 3/16"       | 1/4"         |
| 3/8"            | 1/4-18       | 1/2"        | 3/16"       | 1/4"         |
| 1/2"            | 3/8-18       | 9/16"       | 1/4"        | 1/4"         |
| 5/8"            | 1/2-14       | 5/8"        | 1/4"        | 5/16"        |
| 3/4"            | 3/4-14       | 3/4"        | 1/4"        | 3/8"         |
| 7/8"            | 1-11 1/2     | 3/4"        | 1/4"        | 3/8"         |
| 1"              | 1-11 1/2     | 3/4"        | 1/4"        | 3/8"         |
| 1 1/4"          | 1 1/4-11 1/2 | 7/8"        | 5/16"       | 1/2"         |

### Mounting Flanges, Figure 262

Mounting flanges are recommended for applications where vibration or movement may cause the heater to be dislodged from its hole. Stainless steel flanges are available in a variety of sizes and configurations. The standard flange is round and is supplied with two mounting holes. For heaters 5/8" diameter and under, the flange would be 1 1/2" in diameter. For larger diameter heaters the standard flange would be 2.00" in diameter.



# Cartridge Heaters - other unique features

ASB Heating Elements Ltd.

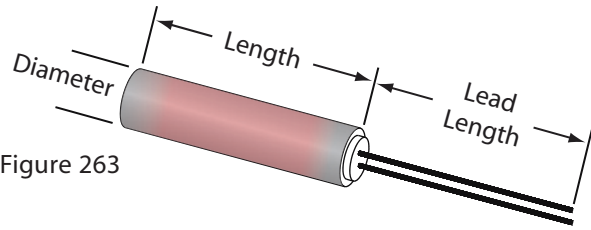

Figure 263

### Teflon End Seal, Figure 263

A Teflon plug is swaged in place along with Teflon leads. This construction resists oil and water to 250°C/480°F. There is a minimum of a 1.00" unheated length at the lead end. Longer cold sections may be required if the watt density or operating temperature is high.

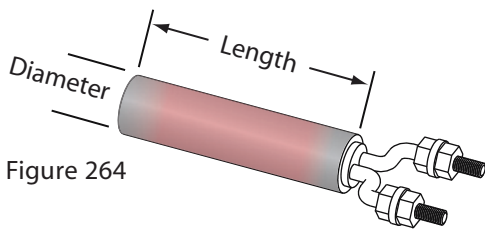

Figure 264

### Screw Terminals, Figure 264

Threaded stud terminals are supplied complete with high temperature nuts and washers. Standard screw is #8-32. Available in 5/8", 3/4", 1", 16 mm and 20mm diameters heaters

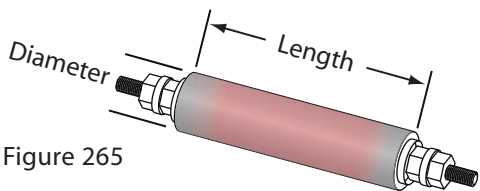

Figure 265

### Double Ended Terminals, Figure 265 & 266

These terminations are ideal for applications where wiring from both ends is required. A minimum cold section of 1" is required for these leads.

- Available Terminations -
- Solid nickel pins
  - Leadwires
  - Threaded studs

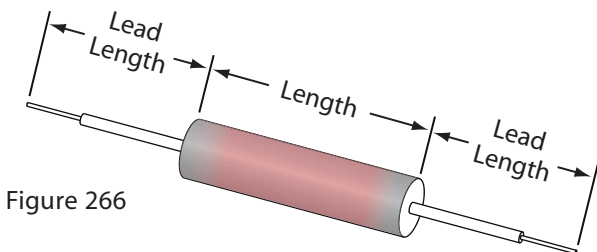

Figure 266

### Terminal Boxes, Figure 267

Terminal boxes are permanently attached to the heater sheath to provide excellent protection in a variety of environments.

- Available Boxes -
- General purpose sheet metal
  - Moisture proof
  - Cast aluminum explosion resistant

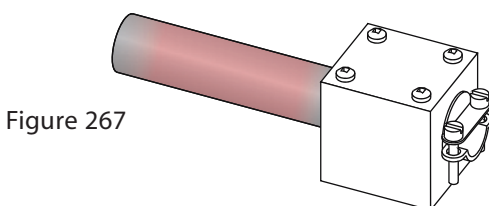
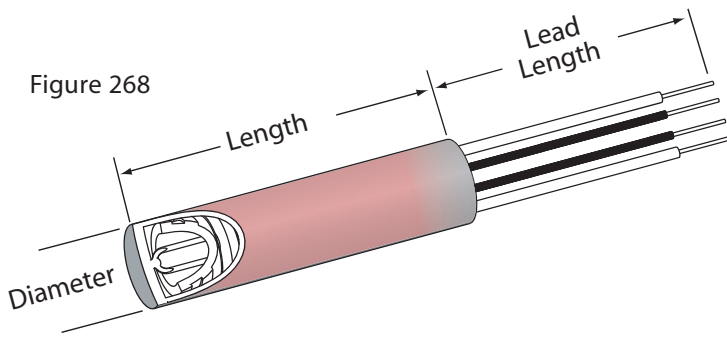

Figure 267

## Internal Thermocouples

Internal thermocouples are built into the heater assembly to monitor the internal or sheath temperatures. These are useful as high limit devices or in applications where space is at a premium. The power and sensor leads exit the sheath together and can be ordered with a variety of lead protections. Not all thermocouple configurations are available on smaller diameter heaters.

Type J and K calibrations are standard for the shown constructions.



### Grounded at Disc End, Figure 268

The thermocouple junction is grounded to the disc end of the heater. This construction is commonly used in hot runner applications. The disc end can be filled with silver solder and ground flat. This will ensure good contact when inserted into a flat end blind hole

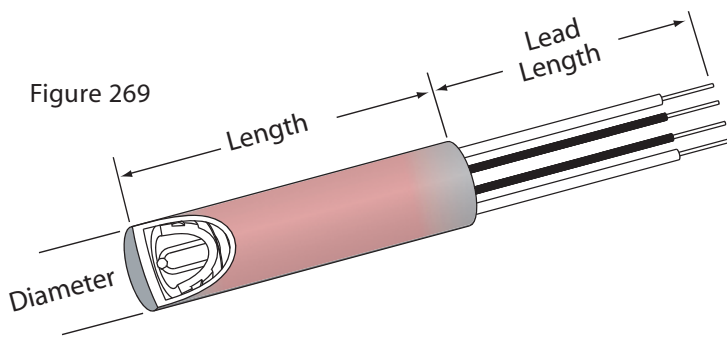

### Ungrounded at Disc End, Figure 269

The thermocouple junction is ungrounded and is located just behind the disc end. This will give a reference temperature of the part being heated.

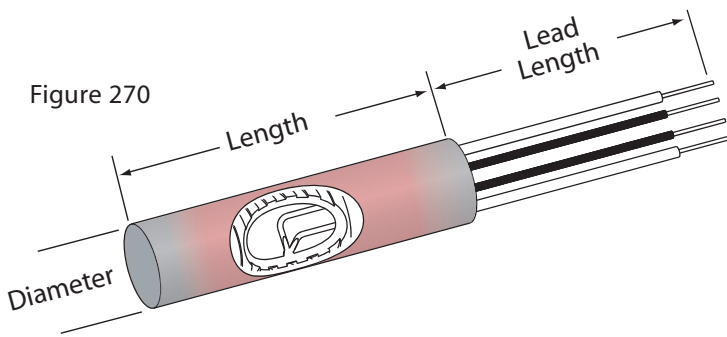

### Grounded at Centre, Figure 270

The thermocouple junction is grounded to the sheath along the length of the heater. The standard location is at the center of the heater, but can be located anywhere along the length of the sheath. This construction will provide a quick response

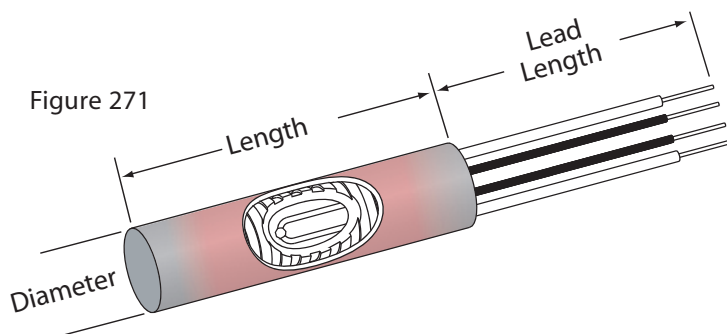

### Ungrounded at Centre, Figure 271

The thermocouple junction is ungrounded and is centered in the diameter of the sheath. The standard location is at the center of the heater, but can be located anywhere along the length of the sheath. Typically used as a high limit in air or vacuum applications



# Cartridge Heaters

ASB Heating Elements Ltd.

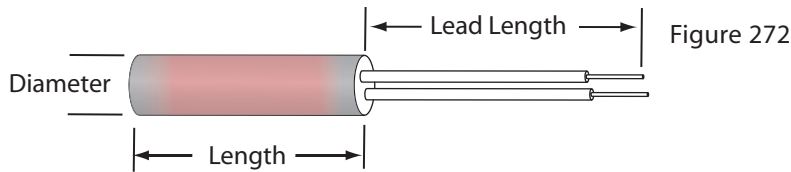

| Dia. | Length | W   | V   | Watts /in <sup>2</sup> | Catalogue Number | Dia. | Length | W   | V   | Watts /in <sup>2</sup> | Catalogue Number |             |
|------|--------|-----|-----|------------------------|------------------|------|--------|-----|-----|------------------------|------------------|-------------|
| 1/8  | 1 1/2  | 30  | 120 | 76                     | CARC01J0001      | 1/4  | 2 1/2  | 250 | 120 | 157                    | CARE02J0037      |             |
|      | 1 1/2  | 60  | 120 | 154                    | CARC01J0002      |      | 2 1/2  | 250 | 240 | 157                    | CARE02J0038      |             |
| 1/8  | 2      | 50  | 120 | 85                     | CARC02A0003      | 1/4  | 2 3/4  | 200 | 240 | 115                    | CARE02N0039      |             |
|      | 2      | 100 | 120 | 172                    | CARC02A0004      |      | 2 3/4  | 300 | 240 | 140                    | CARE02N0040      |             |
| 1/4  | 1      | 80  | 120 | 136                    | CARE01A0005      | 1/4  | 3      | 125 | 120 | 72                     | CARE03A0041      |             |
|      | 1      | 100 | 120 | 127                    | CARE01A0006      |      | 3      | 125 | 240 | 64                     | CARE03A0042      |             |
|      | 1      | 100 | 120 |                        | CARE01A0007      |      | 3      | 200 | 240 | 102                    | CARE03A0043      |             |
| 1/4  | 1 1/4  | 75  | 120 | 130                    | CARE01E0008      | 1/4  | 3      | 200 | 240 | 102                    | CARE03A0044      |             |
|      | 1 1/4  | 150 | 120 | 258                    | CARE01E0009      |      | 3      | 250 | 240 | 126                    | CARE03A0045      |             |
|      | 1 1/4  | 225 | 240 | 388                    | CARE01E0010      |      | 3      | 300 | 120 | 146                    | CARE03A0046      |             |
| 1/4  | 1 1/2  | 30  | 120 | 34                     | CARE01J0011      | 1/4  | 3      | 300 | 240 | 146                    | CARE03A0047      |             |
|      | 1 1/2  | 100 | 120 | 130                    | CARE01J0012      |      | 4      | 100 | 120 |                        | CARE04A0048      |             |
|      | 1 1/2  | 100 | 240 | 130                    | CARE01J0013      |      | 4      | 200 | 120 |                        | CARE04A0049      |             |
|      | 1 1/2  | 125 | 120 | 140                    | CARE01J0014      |      | 4      | 200 | 240 |                        | CARE04A0050      |             |
|      | 1 1/2  | 150 | 120 | 170                    | CARE01J0015      |      | 4      | 300 | 120 |                        | CARE04A0051      |             |
|      | 1 1/2  | 200 | 120 | 258                    | CARE01J0016      |      | 4      | 300 | 120 |                        | CARE04A0052      |             |
|      | 1 1/2  | 200 | 240 | 258                    | CARE01J0017      |      | 4      | 300 | 240 |                        | CARE04A0053      |             |
| 1/4  | 1 3/4  | 150 | 120 | 155                    | CARE01N0018      | 1/4  | 4 1/2  | 350 | 240 |                        | CARE04J0054      |             |
|      | 1 3/4  | 200 | 120 | 207                    | CARE01N0019      | 1/4  | 5      | 200 | 240 |                        | CARE05A0055      |             |
|      | 1 3/4  | 200 | 240 | 207                    | CARE01N0020      |      | 5      | 330 | 240 |                        | CARE05A0056      |             |
|      | 1 3/4  | 300 | 240 | 310                    | CARE01N0021      |      | 5      | 400 | 120 |                        | CARE05A0057      |             |
|      |        |     |     |                        | 5                |      | 400    | 240 |     | CARE05A0058            |                  |             |
| 1/4  | 2      | 40  | 120 | 31                     | CARE02A0022      | 1/4  | 5      | 450 | 240 |                        | CARE05A0059      |             |
|      | 2      | 40  | 240 | 31                     | CARE02A0023      |      | 6      | 300 | 120 |                        | CARE06A0060      |             |
|      | 2      | 75  | 120 | 59                     | CARE02A0024      | 1/4  | 6      | 400 | 240 |                        | CARE06A0061      |             |
|      | 2      | 75  | 120 | 59                     | CARE02A0025      |      | 7      | 400 | 240 |                        | CARE07A0062      |             |
|      | 2      | 125 | 120 | 105                    | CARE02A0026      | 1/4  | 8      | 200 | 240 |                        | CARE08A0063      |             |
|      | 2      | 125 | 240 | 105                    | CARE02A0027      |      | 8      | 300 | 120 |                        | CARE08A0064      |             |
|      | 2      | 150 | 120 | 127                    | CARE02A0028      |      | 8      | 400 | 240 |                        | CARE08A0065      |             |
|      | 2      | 150 | 120 | 127                    | CARE02A0029      |      | 1/4    | 10  | 600 | 240                    |                  | CARE10A0066 |
|      | 2      | 150 | 240 | 127                    | CARE02A0030      | 1/4  |        | 11  | 600 | 240                    |                  | CARE11A0067 |
|      | 2      | 200 | 120 | 157                    | CARE02A0031      |      |        | 1/4 | 13  | 725                    | 240              |             |
|      | 2      | 200 | 240 | 157                    | CARE02A0032      |      |        |     |     |                        |                  |             |
|      | 2      | 200 | 240 | 157                    | CARE02A0033      |      |        |     |     |                        |                  |             |
|      | 2      | 250 | 120 | 215                    | CARE02A0034      |      |        |     |     |                        |                  |             |
|      | 2      | 250 | 240 | 255                    | CARE02A0035      |      |        |     |     |                        |                  |             |
|      | 2      | 300 | 240 | 255                    | CARE02A0036      |      |        |     |     |                        |                  |             |

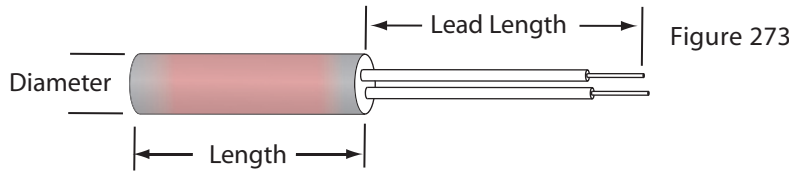

| Dia.  | Length | W     | V   | Watts /in <sup>2</sup> | Catalogue Number |
|-------|--------|-------|-----|------------------------|------------------|
| 3/8   | 1      | 100   | 120 | 170                    | CARG01A0069      |
|       | 1      | 150   | 120 | 256                    | CARG01A0070      |
|       | 1      | 150   | 240 | 256                    | CARG01A0071      |
| 3/8   | 1 1/4  | 50    | 120 | 57                     | CARG01E0072      |
|       | 1 1/4  | 80    | 120 | 108                    | CARG01E0073      |
|       | 1 1/4  | 100   | 120 | 114                    | CARG01E0074      |
|       | 1 1/4  | 125   | 120 | 141                    | CARG01E0075      |
|       | 1 1/4  | 200   | 120 | 228                    | CARG01E0076      |
|       | 1 1/4  | 200   | 240 | 228                    | CARG01E0077      |
| 3/8   | 1 3/8  | 150   | 120 | 146                    | CARG01G0078      |
| 3/8   | 1 7/16 | 100   | 120 | 91                     | CARG01H0079      |
|       | 1 7/16 | 130   | 240 | 118                    | CARG01H0080      |
| 3/8   | 1 1/2  | 30    | 120 | 25                     | CARG01J0081      |
|       | 1 1/2  | 50    | 120 | 42                     | CARG01J0082      |
|       | 1 1/2  | 60    | 120 | 51                     | CARG01J0083      |
|       | 1 1/2  | 75    | 120 | 64                     | CARG01J0084      |
|       | 1 1/2  | 85    | 120 | 72                     | CARG01J0085      |
|       | 1 1/2  | 100   | 240 | 86                     | CARG01J0086      |
|       | 1 1/2  | 150   | 120 | 127                    | CARG01J0087      |
|       | 1 1/2  | 150   | 240 | 127                    | CARG01J0088      |
|       | 1 1/2  | 200   | 120 | 170                    | CARG01J0089      |
|       | 1 1/2  | 200   | 240 | 170                    | CARG01J0090      |
|       | 1 1/2  | 250   | 120 | 212                    | CARG01J0091      |
|       | 1 1/2  | 250   | 240 | 212                    | CARG01J0092      |
|       | 1 1/2  | 250   | 240 | 212                    | CARG01J0093      |
|       | 3/8    | 1 3/4 | 125 | 120                    | 86               |
| 1 3/4 |        | 150   | 240 | 102                    | CARG01N0095      |
| 1 3/4 |        | 175   | 120 | 120                    | CARG01N0096      |
| 1 3/4 |        | 200   | 240 | 136                    | CARG01N0097      |
| 1 3/4 |        | 200   | 240 | 136                    | CARG01N0098      |
| 1 3/4 |        | 250   | 120 | 163                    | CARG01N0099      |
| 1 3/4 |        | 250   | 240 | 163                    | CARG01N0100      |
| 1 3/4 |        | 250   | 240 | 163                    | CARG01N0101      |
| 3/8   | 2      | 50    | 120 | 28                     | CARG02A0102      |
|       | 2      | 75    | 120 | 42                     | CARG02A0103      |
|       | 2      | 100   | 120 | 57                     | CARG02A0104      |
|       | 2      | 100   | 240 | 57                     | CARG02A0105      |
|       | 2      | 150   | 120 | 85                     | CARG02A0106      |
|       | 2      | 150   | 120 | 85                     | CARG02A0107      |

Figure 273

| Dia.  | Length | W   | V   | Watts /in <sup>2</sup> | Catalogue Number |
|-------|--------|-----|-----|------------------------|------------------|
| 3/8   | 2      | 150 | 240 | 85                     | CARG02A0108      |
|       | 2      | 165 | 240 | 94                     | CARG02A0109      |
|       | 2      | 200 | 120 | 114                    | CARG02A0110      |
|       | 2      | 200 | 240 | 114                    | CARG02A0111      |
|       | 2      | 250 | 120 | 141                    | CARG02A0112      |
|       | 2      | 250 | 240 | 141                    | CARG02A0113      |
|       | 2      | 250 | 240 | 141                    | CARG02A0114      |
|       | 2      | 300 | 120 | 170                    | CARG02A0115      |
|       | 2      | 300 | 240 | 170                    | CARG02A0116      |
|       | 2      | 400 | 120 | 226                    | CARG02A0117      |
|       | 2      | 400 | 240 | 226                    | CARG02A0118      |
| 3/8   | 2 1/4  | 75  | 120 | 37                     | CARG02E0119      |
|       | 2 1/4  | 125 | 120 | 62                     | CARG02E0120      |
|       | 2 1/4  | 125 | 240 | 62                     | CARG02E0121      |
|       | 2 1/4  | 250 | 120 | 121                    | CARG02E0122      |
| 3/8   | 2 1/4  | 250 | 240 | 121                    | CARG02E0123      |
|       | 2 1/4  | 250 | 240 | 121                    | CARG02E0124      |
| 3/8   | 2 3/8  | 75  | 120 | 34                     | CARG02G0125      |
|       | 2 3/8  | 165 | 120 | 75                     | CARG02G0126      |
|       | 2 3/8  | 165 | 120 | 75                     | CARG02G0127      |
|       | 2 3/8  | 165 | 240 | 75                     | CARG02G0128      |
|       | 2 3/8  | 200 | 120 | 91                     | CARG02G0129      |
|       | 2 3/8  | 200 | 240 | 91                     | CARG02G0130      |
|       | 2 3/8  | 200 | 240 | 91                     | CARG02G0131      |
|       | 2 3/8  | 250 | 120 | 113                    | CARG02G0132      |
|       | 2 3/8  | 250 | 240 | 113                    | CARG02G0133      |
|       | 2 3/8  | 300 | 120 | 136                    | CARG02G0134      |
|       | 2 3/8  | 300 | 240 | 136                    | CARG02G0135      |
| 2 3/8 | 400    | 120 | 181 | CARG02G0136            |                  |
| 3/8   | 2 1/2  | 100 | 120 | 42                     | CARG02J0137      |
|       | 2 1/2  | 100 | 240 | 42                     | CARG02J0138      |
|       | 2 1/2  | 250 | 240 | 141                    | CARG02J0139      |
|       | 2 1/2  | 400 | 240 | 174                    | CARG02J0140      |
|       | 2 1/2  | 500 | 120 | 215                    | CARG02J0141      |
|       | 2 1/2  | 500 | 240 | 215                    | CARG02J0142      |
| 3/8   | 2 3/4  | 100 | 120 | 38                     | CARG02N0143      |
|       | 2 3/4  | 200 | 120 | 76                     | CARG02N0144      |
|       | 2 3/4  | 250 | 120 | 95                     | CARG02N0145      |
|       | 2 3/4  | 275 | 240 | 104                    | CARG02N0146      |
|       | 2 3/4  | 300 | 240 | 114                    | CARG02N0147      |
|       | 2 3/4  | 500 | 240 | 190                    | CARG02N0148      |



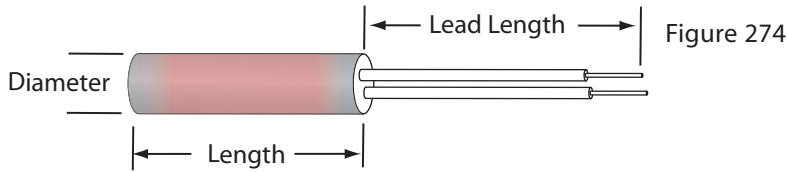

| Dia. | Length | W   | V   | Watts /in <sup>2</sup> | Catalogue Number | Dia.        | Length | W     | V     | Watts /in <sup>2</sup> | Catalogue Number |             |             |
|------|--------|-----|-----|------------------------|------------------|-------------|--------|-------|-------|------------------------|------------------|-------------|-------------|
| 3/8  | 3      | 100 | 120 | 34                     | CARG03A0149      | 3/8         | 4      | 250   | 120   | 61                     | CARG04A0191      |             |             |
|      | 3      | 100 | 120 | 34                     | CARG03A0150      |             | 4      | 250   | 240   | 61                     | CARG04A0192      |             |             |
|      | 3      | 100 | 240 | 34                     | CARG03A0151      |             | 4      | 300   | 120   | 76                     | CARG04A0193      |             |             |
|      | 3      | 150 | 120 | 51                     | CARG03A0152      |             | 4      | 300   | 240   | 76                     | CARG04A0194      |             |             |
|      | 3      | 150 | 240 | 51                     | CARG03A0153      |             | 4      | 400   | 120   | 97                     | CARG04A0195      |             |             |
|      | 3      | 200 | 120 | 68                     | CARG03A0154      |             | 4      | 400   | 120   | 97                     | CARG04A0196      |             |             |
|      | 3      | 200 | 240 | 68                     | CARG03A0155      |             | 4      | 400   | 240   | 97                     | CARG04A0197      |             |             |
|      | 3      | 225 | 240 | 76                     | CARG03A0156      |             | 4      | 450   | 240   | 109                    | CARG04A0198      |             |             |
|      | 3      | 250 | 120 | 106                    | CARG03A0157      |             | 4      | 500   | 120   | 121                    | CARG04A0199      |             |             |
|      | 3      | 250 | 240 | 86                     | CARG03A0158      |             | 4      | 500   | 240   | 121                    | CARG04A0200      |             |             |
|      | 3      | 260 | 240 | 110                    | CARG03A0159      |             | 4      | 600   | 240   | 146                    | CARG04A0201      |             |             |
|      | 3      | 300 | 120 | 102                    | CARG03A0160      |             | 3/8    | 4 1/4 | 400   | 240                    | 91               | CARG04E0202 |             |
|      | 3      | 300 | 120 | 102                    | CARG03A0161      |             |        | 3/8   | 4 1/2 | 300                    | 120              | 65          | CARG04J0203 |
|      | 3      | 300 | 240 | 102                    | CARG03A0162      |             |        |       | 4 1/2 | 300                    | 240              | 65          | CARG04J0204 |
|      | 3      | 300 | 240 | 127                    | CARG03A0163      |             |        |       | 4 1/2 | 400                    | 120              | 85          | CARG04J0205 |
| 3    | 400    | 120 | 136 | CARG03A0164            | 4 1/2            | 400         |        |       | 240   | 85                     | CARG04J0206      |             |             |
| 3    | 400    | 240 | 136 | CARG03A0165            | 4 1/2            | 420         |        |       | 240   | 102                    | CARG04J0207      |             |             |
| 3    | 450    | 240 | 153 | CARG03A0166            | 4 1/2            | 500         |        |       | 120   | 106                    | CARG04J0208      |             |             |
| 3    | 450    | 240 | 191 | CARG03A0167            | 4 1/2            | 500         |        | 240   | 146   | CARG04J0209            |                  |             |             |
| 3    | 500    | 120 | 170 | CARG03A0168            | 3/8              | 4 3/4       |        | 300   | 120   | 60                     | CARG04N0210      |             |             |
| 3/8  | 3      | 500 | 240 | 212                    |                  | CARG03A0169 |        | 4 3/4 | 300   | 240                    | 60               | CARG04N0211 |             |
|      | 3      | 500 | 240 | 212                    |                  | CARG03A0170 |        | 4 3/4 | 400   | 120                    | 80               | CARG04N0212 |             |
|      | 3      | 600 | 240 | 206                    |                  | CARG03A0171 |        | 4 3/4 | 400   | 240                    | 80               | CARG04N0213 |             |
| 3/8  | 3 1/2  | 120 | 120 | 34                     | CARG03J0172      | 4 3/4       |        | 500   | 240   | 98                     | CARG04N0214      |             |             |
|      | 3 1/2  | 250 | 240 | 71                     | CARG03J0173      | 3/8         |        | 5     | 150   | 120                    | 29               | CARG05A0215 |             |
|      | 3 1/2  | 300 | 120 | 85                     | CARG03J0174      |             |        | 5     | 150   | 240                    | 29               | CARG05A0216 |             |
|      | 3 1/2  | 300 | 240 | 85                     | CARG03J0175      |             | 5      | 200   | 120   | 38                     | CARG05A0217      |             |             |
|      | 3 1/2  | 320 | 240 | 90                     | CARG03J0176      |             | 5      | 300   | 120   | 57                     | CARG05A0218      |             |             |
|      | 3 1/2  | 350 | 120 | 92                     | CARG03J0177      |             | 5      | 300   | 240   | 57                     | CARG05A0219      |             |             |
|      | 3 1/2  | 350 | 240 | 92                     | CARG03J0178      |             | 5      | 400   | 120   | 75                     | CARG05A0220      |             |             |
|      | 3 1/2  | 400 | 240 | 113                    | CARG03J0179      |             | 5      | 470   | 240   | 90                     | CARG05A0221      |             |             |
|      | 3 1/2  | 500 | 120 | 142                    | CARG03J0180      |             | 5      | 500   | 120   | 95                     | CARG05A0222      |             |             |
|      | 3 1/2  | 500 | 240 | 142                    | CARG03J0181      |             | 5      | 500   | 240   | 95                     | CARG05A0223      |             |             |
| 3/8  | 3 3/4  | 175 | 240 | 46                     | CARG03N0182      |             | 5      | 500   | 240   | 95                     | CARG05A0224      |             |             |
|      | 3 3/4  | 300 | 240 | 79                     | CARG03N0183      | 5           | 500    | 240   | 95    | CARG05A0225            |                  |             |             |
|      | 3 3/4  | 400 | 240 | 105                    | CARG03N0184      | 5           | 750    | 240   | 141   | CARG05A0226            |                  |             |             |
|      | 3 3/4  | 500 | 240 | 130                    | CARG03N0185      | 5           | 1000   | 240   | 195   | CARG05A0227            |                  |             |             |
| 3/8  | 4      | 125 | 120 | 30                     | CARG04A0186      | 3/8         | 5 1/2  | 250   | 240   | 43                     | CARG05J0227      |             |             |
|      | 4      | 125 | 240 | 30                     | CARG04A0187      |             | 5 1/2  | 300   | 240   | 51                     | CARG05J0228      |             |             |
|      | 4      | 150 | 120 | 36                     | CARG04A0188      |             | 5 1/2  | 600   | 240   | 102                    | CARG05J0229      |             |             |
|      | 4      | 150 | 240 | 36                     | CARG04A0189      |             |        |       |       |                        |                  |             |             |
|      | 4      | 200 | 120 | 49                     | CARG04A0190      |             |        |       |       |                        |                  |             |             |





ASB Heating Elements Ltd.

# Cartridge Heaters

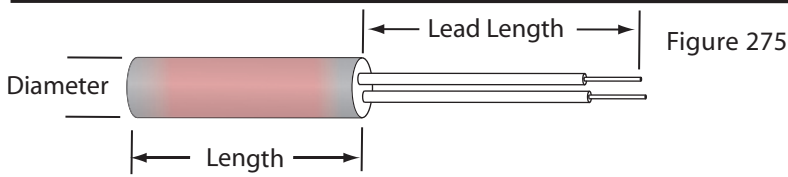

| Dia.  | Length | W    | V   | Watts /in <sup>2</sup> | Catalogue Number | Dia.        | Length | W     | V    | Watts /in <sup>2</sup> | Catalogue Number |             |
|-------|--------|------|-----|------------------------|------------------|-------------|--------|-------|------|------------------------|------------------|-------------|
| 3/8   | 5 3/4  | 400  | 240 | 65                     | CARG05N0230      | 3/8         | 8      | 300   | 120  | 34                     | CARG08A0265      |             |
|       | 5 3/4  | 500  | 240 | 81                     | CARG05N0231      |             | 8      | 300   | 240  | 34                     | CARG08A0266      |             |
|       | 5 3/4  | 600  | 120 | 97                     | CARG05N0232      |             | 8      | 300   | 240  | 34                     | CARG08A0267      |             |
|       | 5 3/4  | 600  | 240 | 97                     | CARG05N0233      |             | 8      | 500   | 120  | 57                     | CARG08A0268      |             |
| 3/8   | 6      | 225  | 120 | 35                     | CARG06A0234      |             | 8      | 500   | 240  | 57                     | CARG08A0269      |             |
|       | 6      | 225  | 240 | 35                     | CARG06A0235      |             | 8      | 600   | 120  | 68                     | CARG08A0270      |             |
|       | 6      | 400  | 120 | 58                     | CARG06A0236      |             | 8      | 600   | 240  | 68                     | CARG08A0271      |             |
|       | 6      | 400  | 240 | 58                     | CARG06A0237      |             | 8      | 650   | 240  | 79                     | CARG08A0272      |             |
|       | 6      | 500  | 120 | 77                     | CARG06A0238      |             | 8      | 775   | 240  | 96                     | CARG08A0273      |             |
|       | 6      | 500  | 240 | 77                     | CARG06A0239      |             | 8      | 1000  | 240  | 113                    | CARG08A0274      |             |
|       | 6      | 500  | 240 | 77                     | CARG06A0240      |             | 3/8    | 9     | 500  | 240                    | 50               | CARG09A0275 |
|       | 6      | 500  | 240 | 77                     | CARG06A0241      |             |        | 9     | 885  | 240                    | 94               | CARG09A0276 |
|       | 6      | 575  | 240 | 85                     | CARG06A0242      | 9           |        | 1000  | 240  | 100                    | CARG09A0277      |             |
|       | 3/8    | 6    | 600 | 120                    | 93               | CARG06A0242 | 3/8    | 9 1/2 | 600  | 240                    | 57               | CARG09J0278 |
|       |        | 6    | 600 | 240                    | 93               | CARG06A0243 |        | 9 1/2 | 1000 | 240                    | 95               | CARG09J0279 |
|       |        | 6    | 600 | 240                    | 93               | CARG06A0244 | 3/8    | 10    | 600  | 120                    | 54               | CARG10A0280 |
| 6     |        | 600  | 240 | 93                     | CARG06A0245      | 10          |        | 600   | 240  | 54                     | CARG10A0281      |             |
| 6     |        | 750  | 240 | 116                    | CARG06A0245      | 10          |        | 1000  | 240  | 90                     | CARG10A0282      |             |
| 6     |        | 1000 | 240 | 165                    | CARG06A0246      | 3/8         | 12     | 500   | 240  | 37                     | CARG12A0283      |             |
| 3/8   | 6 1/2  | 600  | 240 | 86                     | CARG06J0247      |             | 12     | 600   | 240  | 44                     | CARG12A0284      |             |
|       | 6 1/2  | 1000 | 240 | 142                    | CARG06J0248      |             | 12     | 1000  | 240  | 74                     | CARG12A0285      |             |
| 3/8   | 6 3/4  | 300  | 240 | 41                     | CARG06N0249      | 3/8         | 12 3/4 | 1000  | 240  | 68                     | CARG12N0286      |             |
|       | 7      | 350  | 120 | 46                     | CARG07A0250      |             | 1/2    | 1 1/4 | 125  | 120                    | 108              | CARJ01E0287 |
|       | 7      | 350  | 240 | 46                     | CARG07A0251      |             |        | 1 1/4 | 125  | 240                    | 108              | CARJ01E0288 |
|       | 7      | 400  | 120 | 52                     | CARG07A0252      | 1 1/4       |        | 200   | 240  | 171                    | CARJ01E0289      |             |
|       | 7      | 450  | 240 | 60                     | CARG07A0253      | 1/2         | 1 1/2  | 150   | 120  | 96                     | CARJ01J0290      |             |
|       | 7      | 500  | 240 | 65                     | CARG07A0254      |             | 1 1/2  | 150   | 240  | 96                     | CARJ01J0291      |             |
|       | 7      | 500  | 240 | 65                     | CARG07A0254      |             | 1 1/2  | 200   | 120  | 128                    | CARJ01J0292      |             |
|       | 7      | 600  | 240 | 80                     | CARG07A0255      |             | 1 1/2  | 200   | 240  | 128                    | CARJ01J0293      |             |
|       | 7      | 675  | 240 | 95                     | CARG07A0256      | 1 1/2       | 250    | 240   | 159  | CARJ01J0294            |                  |             |
|       | 7      | 1000 | 240 | 131                    | CARG07A0257      | 1/2         | 1 3/4  | 200   | 240  | 102                    | CARJ01N0295      |             |
| 3/8   | 7 1/4  | 600  | 240 | 76                     | CARG07E0258      |             | 1 3/4  | 250   | 120  | 128                    | CARJ01N0296      |             |
|       | 7 1/2  | 300  | 240 | 36                     | CARG07J0259      |             | 1 3/4  | 300   | 240  | 154                    | CARJ01N0297      |             |
| 7 1/2 | 600    | 120  | 73  | CARG07J0260            | 1 3/4            |             | 400    | 240   | 205  | CARJ01N0298            |                  |             |
| 7 1/2 | 600    | 120  | 73  | CARG07J0261            |                  |             |        |       |      |                        |                  |             |
| 7 1/2 | 600    | 240  | 73  | CARG07J0262            |                  |             |        |       |      |                        |                  |             |
| 7 1/2 | 1000   | 240  | 122 | CARG07J0263            |                  |             |        |       |      |                        |                  |             |
| 3/8   | 7 3/4  | 750  | 240 | 85                     | CARG07N0264      |             |        |       |      |                        |                  |             |

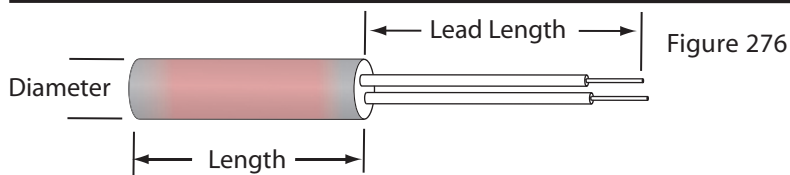

| Dia. | Length | W   | V   | Watts /in <sup>2</sup> | Catalogue Number | Dia.  | Length | W     | V   | Watts /in <sup>2</sup> | Catalogue Number |             |
|------|--------|-----|-----|------------------------|------------------|-------|--------|-------|-----|------------------------|------------------|-------------|
| 1/2  | 2      | 130 | 240 | 55                     | CARJ02A0299      | 1/2   | 3      | 400   | 120 | 102                    | CARJ03A0339      |             |
|      | 2      | 200 | 120 | 85                     | CARJ02A0300      |       | 3      | 400   | 240 | 102                    | CARJ03A0340      |             |
|      | 2      | 200 | 240 | 85                     | CARJ02A0301      |       | 3      | 500   | 120 | 127                    | CARJ03A0341      |             |
|      | 2      | 250 | 120 | 106                    | CARJ02A0302      |       | 3      | 500   | 240 | 127                    | CARJ03A0342      |             |
|      | 2      | 250 | 240 | 106                    | CARJ02A0303      |       | 3      | 600   | 120 | 153                    | CARJ03A0343      |             |
|      | 2      | 300 | 120 | 128                    | CARJ02A0304      |       | 3      | 600   | 240 | 153                    | CARJ03A0344      |             |
|      | 2      | 300 | 240 | 128                    | CARJ02A0305      |       | 3      | 750   | 120 | 192                    | CARJ03A0345      |             |
|      | 2      | 400 | 120 | 170                    | CARJ02A0306      |       | 3      | 750   | 240 | 192                    | CARJ03A0346      |             |
|      | 2      | 400 | 240 | 170                    | CARJ02A0307      |       | 1/2    | 3 1/2 | 250 | 120                    | 53               | CARJ03J0347 |
|      | 2      | 500 | 120 | 214                    | CARJ02A0308      |       |        | 3 1/2 | 250 | 240                    | 53               | CARJ03J0348 |
| 1/2  | 2 1/4  | 125 | 120 | 45                     | CARJ02E0309      | 3 1/2 |        | 350   | 240 | 75                     | CARJ03J0349      |             |
|      | 2 1/4  | 250 | 120 | 91                     | CARJ02E0310      | 3 1/2 |        | 420   | 240 | 97                     | CARJ03J0350      |             |
|      | 2 1/4  | 250 | 240 | 91                     | CARJ02E0311      | 3 1/2 |        | 500   | 120 | 106                    | CARJ03J0351      |             |
|      | 2 1/4  | 400 | 120 | 147                    | CARJ02E0312      | 3 1/2 | 500    | 240   | 106 | CARJ03J0352            |                  |             |
|      | 2 1/4  | 400 | 240 | 147                    | CARJ02E0313      | 1/2   | 3 3/4  | 250   | 120 | 49                     | CARJ03N0353      |             |
| 1/2  | 2 3/8  | 100 | 240 | 25                     | CARJ02G0314      |       | 3 3/4  | 500   | 120 | 98                     | CARJ03N0354      |             |
|      | 2 3/8  | 225 | 120 | 76                     | CARJ02G0315      |       | 3 3/4  | 500   | 240 | 98                     | CARJ03N0355      |             |
|      | 2 3/8  | 400 | 120 | 136                    | CARJ02G0316      |       | 3 3/4  | 1000  | 240 | 197                    | CARJ03N0356      |             |
|      | 2 3/8  | 400 | 240 | 136                    | CARJ02G0317      | 1/2   | 4      | 150   | 120 | 27                     | CARJ04A0357      |             |
|      | 2 3/8  | 475 | 120 | 161                    | CARJ02G0318      |       | 4      | 150   | 240 | 27                     | CARJ04A0358      |             |
|      | 2 3/8  | 475 | 240 | 161                    | CARJ02G0319      |       | 4      | 250   | 120 | 45                     | CARJ04A0359      |             |
| 1/2  | 2 1/2  | 100 | 120 | 32                     | CARJ02J0320      |       | 4      | 250   | 240 | 45                     | CARJ04A0360      |             |
|      | 2 1/2  | 100 | 240 | 32                     | CARJ02J0321      |       | 4      | 300   | 120 | 56                     | CARJ04A0361      |             |
|      | 2 1/2  | 120 | 120 | 38                     | CARJ02J0322      |       | 4      | 300   | 240 | 56                     | CARJ04A0362      |             |
|      | 2 1/2  | 150 | 240 | 46                     | CARJ02J0323      |       | 4      | 400   | 120 | 73                     | CARJ04A0363      |             |
|      | 2 1/2  | 300 | 120 | 96                     | CARJ02J0324      |       | 4      | 400   | 240 | 73                     | CARJ04A0364      |             |
|      | 2 1/2  | 300 | 240 | 96                     | CARJ02J0325      |       | 4      | 400   | 240 | 73                     | CARJ04A0365      |             |
|      | 2 1/2  | 500 | 120 | 160                    | CARJ02J0326      |       | 4      | 490   | 240 | 90                     | CARJ04A0366      |             |
|      | 2 1/2  | 500 | 240 | 160                    | CARJ02J0327      | 4     | 500    | 120   | 91  | CARJ04A0367            |                  |             |
| 1/2  | 2 3/4  | 250 | 120 | 71                     | CARJ02N0328      | 4     | 500    | 240   | 91  | CARJ04A0368            |                  |             |
|      | 2 3/4  | 400 | 120 | 114                    | CARJ02N0329      | 4     | 750    | 240   | 137 | CARJ04A0369            |                  |             |
|      | 2 3/4  | 400 | 240 | 114                    | CARJ02N0330      | 4     | 1000   | 240   | 184 | CARJ04A0370            |                  |             |
| 1/2  | 3      | 150 | 120 | 38                     | CARJ03A0331      | 1/2   | 4 1/2  | 300   | 240 | 48                     | CARJ04J0371      |             |
|      | 3      | 150 | 240 | 38                     | CARJ03A0332      |       | 4 1/2  | 350   | 120 | 56                     | CARJ04J0372      |             |
|      | 3      | 200 | 120 | 51                     | CARJ03A0333      |       | 4 1/2  | 500   | 240 | 80                     | CARJ04J0373      |             |
|      | 3      | 200 | 240 | 51                     | CARJ03A0334      |       | 4 1/2  | 750   | 240 | 119                    | CARJ04J0374      |             |
|      | 3      | 250 | 120 | 64                     | CARJ03A0335      | 1/2   | 4 3/4  | 200   | 240 | 30                     | CARJ04N0375      |             |
|      | 3      | 250 | 240 | 64                     | CARJ03A0336      |       | 4 3/4  | 300   | 240 | 44                     | CARJ04N0376      |             |
|      | 3      | 300 | 120 | 76                     | CARJ03A0337      |       | 4 3/4  | 500   | 240 | 75                     | CARJ04N0377      |             |
|      | 3      | 300 | 240 | 76                     | CARJ03A0338      |       | 4-3/4  | 1000  | 240 | 148                    | CARJ04N0378      |             |



ASB Heating Elements Ltd.

# Cartridge Heaters

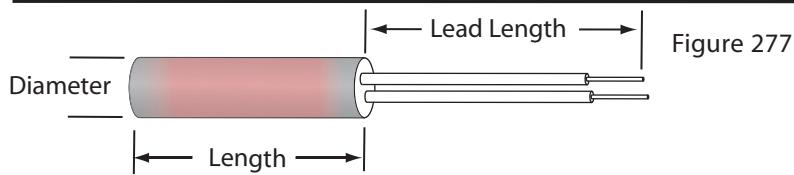

| Dia.  | Length  | W     | V    | Watts /in <sup>2</sup> | Catalogue Number | Dia.        | Length | W     | V    | Watts /in <sup>2</sup> | Catalogue Number |             |
|-------|---------|-------|------|------------------------|------------------|-------------|--------|-------|------|------------------------|------------------|-------------|
| 1/2   | 5       | 200   | 120  | 28                     | CARJ05A0379      | 1/2         | 6 3/4  | 500   | 120  | 51                     | CARJ06N0418      |             |
|       | 5       | 200   | 240  | 28                     | CARJ05A0380      |             | 6 3/4  | 500   | 240  | 51                     | CARJ06N0419      |             |
|       | 5       | 300   | 240  | 42                     | CARJ05A0381      | 1/2         | 7      | 350   | 240  | 34                     | CARJ07A0420      |             |
|       | 5       | 350   | 120  | 50                     | CARJ05A0382      |             | 7      | 500   | 120  | 49                     | CARJ07A0421      |             |
|       | 5       | 350   | 240  | 50                     | CARJ05A0383      |             | 7      | 500   | 240  | 49                     | CARJ07A0422      |             |
|       | 5       | 400   | 120  | 57                     | CARJ05A0384      |             | 7      | 600   | 240  | 59                     | CARJ07A0423      |             |
|       | 5       | 400   | 240  | 57                     | CARJ05A0385      |             | 7      | 900   | 240  | 95                     | CARJ07A0424      |             |
|       | 5       | 500   | 240  | 71                     | CARJ05A0386      |             | 7      | 1000  | 240  | 98                     | CARJ07A0425      |             |
|       | 5       | 625   | 240  | 99                     | CARJ05A0387      | 1/2         | 7 1/2  | 500   | 240  | 46                     | CARJ07J0426      |             |
|       | 5       | 750   | 240  | 107                    | CARJ05A0388      |             | 7 1/2  | 1000  | 240  | 91                     | CARJ07J0427      |             |
|       | 5       | 800   | 240  | 113                    | CARJ05A0389      | 1/2         | 7 3/4  | 1000  | 240  | 88                     | CARJ07N0428      |             |
|       | 5       | 1000  | 240  | 142                    | CARJ05A0390      |             | 7 3/4  | 1200  | 240  | 106                    | CARJ07N0429      |             |
|       |         |       |      |                        | 7 3/4            |             | 1500   | 240   | 132  | CARJ07N0430            |                  |             |
| 1/2   | 5 1/4   | 250   | 120  | 33                     | CARJ05E0391      | 1/2         | 8      | 300   | 120  | 25                     | CARJ08A0431      |             |
|       | 5 1/4   | 250   | 240  | 33                     | CARJ05E0392      |             | 8      | 300   | 240  | 25                     | CARJ08A0432      |             |
|       | 5 1/2   | 500   | 120  | 65                     | CARJ05J0393      |             | 8      | 400   | 120  | 34                     | CARJ08A0433      |             |
|       | 5 1/2   | 500   | 240  | 65                     | CARJ05J0394      |             | 8      | 400   | 240  | 34                     | CARJ08A0434      |             |
| 5 1/2 | 700     | 240   | 89   | CARJ05J0395            | 8                |             | 500    | 120   | 42   | CARJ08A0435            |                  |             |
| 5 1/2 | 750     | 240   | 96   | CARJ05J0396            | 8                |             | 500    | 240   | 42   | CARJ08A0436            |                  |             |
| 1/2   | 5 3/4   | 350   | 240  | 42                     | CARJ05N0397      |             | 8      | 600   | 240  | 51                     | CARJ08A0437      |             |
|       | 5 3/4   | 500   | 120  | 61                     | CARJ05N0398      |             | 8      | 800   | 240  | 68                     | CARJ08A0438      |             |
|       | 5 3/4   | 500   | 240  | 61                     | CARJ05N0399      | 8           | 1000   | 240   | 85   | CARJ08A0439            |                  |             |
|       | 5 3/4   | 1000  | 240  | 122                    | CARJ05N0400      | 8           | 1000   | 240   | 85   | CARJ08A0440            |                  |             |
| 1/2   | 5 13/16 | 700   | 240  | 84                     | CARJ05P0401      | 8           | 1050   | 240   | 93   | CARJ08A0441            |                  |             |
| 1/2   | 6       | 200   | 120  | 23                     | CARJ06A0402      | 8           | 1500   | 240   | 130  | CARJ08A0442            |                  |             |
|       | 6       | 300   | 120  | 35                     | CARJ06A0403      | 8           | 1500   | 240   | 130  | CARJ08A0443            |                  |             |
|       | 6       | 300   | 240  | 35                     | CARJ06A0404      | 8           | 2000   | 240   | 171  | CARJ08A0444            |                  |             |
|       | 6       | 350   | 240  | 40                     | CARJ06A0405      | 1/2         | 8 1/2  | 300   | 240  | 23                     | CARJ08J0445      |             |
|       | 6       | 500   | 120  | 58                     | CARJ06A0406      |             | 8 1/2  | 500   | 240  | 40                     | CARJ08J0446      |             |
|       | 6       | 500   | 240  | 58                     | CARJ06A0407      |             | 8 1/2  | 1000  | 240  | 85                     | CARJ08J0447      |             |
|       | 6       | 500   | 240  | 58                     | CARJ06A0408      |             | 8 1/2  | 1000  | 240  | 85                     | CARJ08J0448      |             |
|       | 6       | 700   | 240  | 82                     | CARJ06A0409      |             | 8 1/2  | 1100  | 240  | 93                     | CARJ08J0449      |             |
|       | 6       | 750   | 240  | 88                     | CARJ06A0410      |             | 1/2    | 8 3/4 | 1000 | 240                    | 77               | CARJ08N0450 |
|       | 6       | 775   | 240  | 99                     | CARJ06A0411      | 1/2         |        | 9     | 500  | 240                    | 37               | CARJ09A0451 |
|       | 6       | 1000  | 120  | 116                    | CARJ06A0412      |             | 9      | 900   | 240  | 70                     | CARJ09A0452      |             |
|       | 6       | 1000  | 240  | 116                    | CARJ06A0413      |             | 9      | 1000  | 240  | 75                     | CARJ09A0453      |             |
|       | 6       | 1000  | 240  | 116                    | CARJ06A0414      |             | 9      | 1200  | 240  | 98                     | CARJ09A0454      |             |
|       | 6       | 1200  | 240  | 140                    | CARJ06A0415      |             | 1/2    | 9 1/2 | 500  | 240                    | 35               | CARJ09J0455 |
|       | 1/2     | 6 1/2 | 500  | 240                    |                  | CARJ06J0416 |        |       |      |                        |                  |             |
|       |         | 6 1/2 | 1000 | 240                    |                  | CARJ06J0417 |        |       |      |                        |                  |             |



ASB Heating Elements Ltd.

# Cartridge Heaters

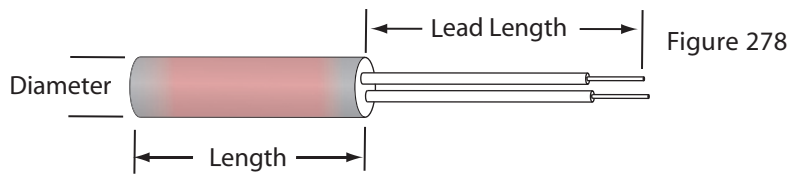

| Dia. | Length | W    | V   | Watts /in <sup>2</sup> | Catalogue Number | Dia. | Length | W    | V   | Watts /in <sup>2</sup> | Catalogue Number |
|------|--------|------|-----|------------------------|------------------|------|--------|------|-----|------------------------|------------------|
|      | 9 1/2  | 1000 | 240 | 71                     | CARJ09J0456      | 5/8  | 1 1/2  | 250  | 120 | 126                    | CARL01J0488      |
|      |        |      |     |                        |                  | 5/8  | 1 1/2  | 250  | 240 | 126                    | CARL01J0489      |
| 1/2  | 10     | 500  | 120 | 34                     | CARJ10A0457      | 5/8  | 2      | 200  | 120 | 68                     | CARL02A0490      |
|      | 10     | 500  | 240 | 34                     | CARJ10A0458      | 5/8  | 2      | 200  | 240 | 68                     | CARL02A0491      |
|      | 10     | 600  | 240 | 40                     | CARJ10A0459      | 5/8  | 2 3/8  | 280  | 120 | 81                     | CARL02G0492      |
|      | 10     | 750  | 240 | 50                     | CARJ10A0460      | 5/8  | 2 3/8  | 280  | 120 | 81                     | CARL02G0493      |
|      | 10     | 1000 | 240 | 67                     | CARJ10A0461      | 5/8  | 2 3/8  | 280  | 240 | 81                     | CARL02G0494      |
|      | 10     | 1000 | 240 | 67                     | CARJ10A0462      | 5/8  | 2 3/8  | 350  | 120 | 102                    | CARL02G0495      |
|      | 10     | 1500 | 240 | 101                    | CARJ10A0463      | 5/8  | 2 3/8  | 350  | 120 | 102                    | CARL02G0496      |
|      | 10     | 1500 | 120 | 101                    | CARJ10A0464      | 5/8  | 2 1/2  | 150  | 120 | 41                     | CARL02J0497      |
|      | 10     | 2000 | 240 | 134                    | CARJ10A0465      | 5/8  | 2 1/2  | 180  | 120 | 49                     | CARL02J0498      |
| 1/2  | 10 1/8 | 1000 | 120 | 74                     | CARJ10C0466      | 5/8  | 2 1/2  | 200  | 120 | 54                     | CARL02J0499      |
| 1/2  | 10 1/8 | 1400 | 240 | 94                     | CARJ10J0467      | 5/8  | 2 1/2  | 275  | 120 |                        | CARL02J1500      |
| 1/2  | 11     | 1000 | 240 | 61                     | CARJ11A0468      | 5/8  | 3      | 150  | 120 | 30                     | CARL03A0501      |
|      | 11     | 1470 | 240 | 88                     | CARJ11A0469      | 5/8  | 3      | 250  | 120 | 51                     | CARL03A0502      |
|      | 11     | 1500 | 240 | 91                     | CARJ11A0470      | 5/8  | 3      | 250  | 240 | 51                     | CARL03A0503      |
| 1/2  | 11 1/2 | 1525 | 240 | 94                     | CARJ11J0471      | 5/8  | 3      | 500  | 120 | 107                    | CARL03A0504      |
| 1/2  | 12     | 500  | 240 | 28                     | CARJ12A0472      | 5/8  | 3      | 500  | 240 | 107                    | CARL03A0505      |
|      | 12     | 1000 | 240 | 55                     | CARJ12A0473      | 5/8  | 3      | 500  | 240 | 107                    | CARL03A0506      |
|      | 12     | 1000 | 240 | 55                     | CARJ12A0474      | 5/8  | 3      | 750  | 240 | 154                    | CARL03A0507      |
|      | 12     | 1000 | 240 | 55                     | CARJ12A0475      | 5/8  | 3 1/2  | 525  | 240 | 93                     | CARL03J0508      |
|      | 12     | 1500 | 240 | 83                     | CARJ12A0476      | 5/8  | 3 3/4  | 240  | 120 | 39                     | CARL03N0509      |
|      | 12     | 1500 | 240 | 83                     | CARJ12A0477      | 5/8  | 3 3/4  | 240  | 240 | 39                     | CARL03N0510      |
|      | 12     | 2000 | 240 | 111                    | CARJ12A0478      | 5/8  | 3 3/4  | 525  | 120 | 86                     | CARL03N0511      |
| 1/2  | 12 1/2 | 1675 | 240 | 92                     | CARJ12J0479      | 5/8  | 3 3/4  | 525  | 120 | 86                     | CARL03N0512      |
| 1/2  | 14     | 1000 | 240 | 47                     | CARJ14A0480      | 5/8  | 3 3/4  | 525  | 240 | 86                     | CARL03N0513      |
|      | 14     | 1700 | 240 | 83                     | CARJ14A0481      | 5/8  | 3 3/4  | 750  | 240 | 118                    | CARL03N0514      |
|      | 14     | 2300 | 240 | 108                    | CARJ14A0482      | 5/8  | 4      | 250  | 120 | 38                     | CARL04A0515      |
| 1/2  | 15     | 2000 | 240 | 88                     | CARJ15A0483      | 5/8  | 4      | 250  | 240 | 38                     | CARL04A0516      |
| 1/2  | 16     | 900  | 240 | 37                     | CARJ16A0484      | 5/8  | 4      | 400  | 240 | 58                     | CARL04A0517      |
| 1/2  | 16 1/2 | 2200 | 240 | 90                     | CARJ16J0485      | 5/8  | 4      | 500  | 240 | 73                     | CARL04A0518      |
| 1/2  | 18     | 1700 | 240 | 62                     | CARJ18A0486      | 5/8  | 4      | 525  | 240 | 79                     | CARL04A0519      |
| 1/2  | 19 1/2 | 2875 | 240 | 99                     | CARJ19JA0487     | 5/8  | 4      | 600  | 240 | 88                     | CARL04A0520      |
|      |        |      |     |                        |                  | 5/8  | 4      | 750  | 240 | 113                    | CARL04A0521      |
|      |        |      |     |                        |                  | 5/8  | 4      | 1000 | 240 | 151                    | CARL04A0522      |
|      |        |      |     |                        |                  | 5/8  | 4 1/2  | 700  | 120 | 92                     | CARL04J0523      |
|      |        |      |     |                        |                  | 5/8  | 4 1/2  | 700  | 240 | 92                     | CARL04J0524      |



ASB Heating Elements Ltd.

# Cartridge Heaters

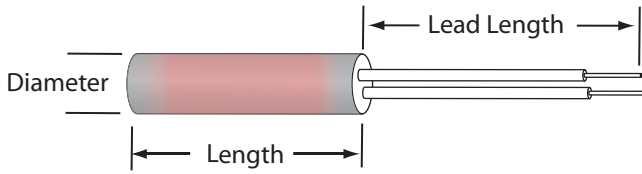

Figure 279

| Dia. | Length | W    | V   | Watts /in <sup>2</sup> | Catalogue Number | Dia. | Length | W    | V   | Watts /in <sup>2</sup> | Catalogue Number |    |             |
|------|--------|------|-----|------------------------|------------------|------|--------|------|-----|------------------------|------------------|----|-------------|
| 5/8  | 4 3/4  | 250  | 240 |                        | CARL04N0525      | 8    | 8      | 1200 | 240 | 83                     | CARL08A0562      |    |             |
|      | 4 3/4  | 750  | 240 | 90                     | CARL04N0526      |      |        | 1500 | 240 | 102                    | CARL08A0563      |    |             |
| 5/8  | 5      | 250  | 240 | 27                     | CARL05A0527      | 5/8  | 8 3/4  | 1700 | 240 | 105                    | CARL08N0564      |    |             |
|      | 5      | 300  | 240 | 35                     | CARL05A0528      |      |        |      |     |                        |                  |    |             |
|      | 5      | 500  | 240 | 56                     | CARL05A0529      |      |        |      |     |                        |                  |    |             |
|      | 5      | 750  | 240 | 86                     | CARL05A0530      |      |        |      |     |                        |                  |    |             |
|      | 5      | 1000 | 240 | 112                    | CARL05A0531      |      |        |      |     |                        |                  |    |             |
| 5/8  | 5 3/8  | 800  | 120 | 86                     | CARL05G0532      | 5/8  | 10     | 500  | 240 | 27                     | CARL10A0568      |    |             |
|      | 5 3/8  | 800  | 240 | 86                     | CARL05G0533      |      |        | 600  | 240 | 33                     | CARL10A0569      |    |             |
| 5/8  | 5 3/4  | 500  | 240 | 48                     | CARL05N0534      |      |        | 650  | 120 | 35                     | CARL10A0570      |    |             |
|      |        | 1000 | 240 | 97                     | CARL05N0535      |      |        | 750  | 240 | 84                     | CARL10A0571      |    |             |
|      |        | 1500 | 240 | 146                    | CARL05N0536      |      |        | 1000 | 240 | 54                     | CARL10A0572      |    |             |
| 5/8  | 6      | 300  | 240 | 28                     | CARL06A0537      |      |        | 1000 | 240 | 54                     | CARL10A0573      |    |             |
|      |        | 375  | 240 | 36                     | CARL06A0538      |      |        | 1500 | 240 | 81                     | CARL10A0574      |    |             |
|      |        | 500  | 240 | 47                     | CARL06A0539      |      |        | 2000 | 240 | 108                    | CARL10A0575      |    |             |
|      |        | 600  | 240 | 57                     | CARL06A0540      |      |        | 5/8  | 11  | 1000                   | 240              | 51 | CARL11A0576 |
|      |        | 750  | 240 | 71                     | CARL06A0541      |      |        |      |     | 1500                   | 240              | 74 | CARL11A0577 |
|      |        | 1000 | 240 | 95                     | CARL06A0542      | 5/8  | 12     |      |     | 500                    | 240              | 22 | CARL12A0578 |
|      |        | 1000 | 240 | 95                     | CARL06A0543      |      |        | 775  | 240 | 35                     | CARL12A0579      |    |             |
|      |        | 1500 | 240 | 139                    | CARL06A0544      |      |        | 1000 | 240 | 46                     | CARL12A0580      |    |             |
| 5/8  | 6 1/2  | 350  | 120 | 30                     | CARL06J0545      |      |        | 1500 | 240 | 67                     | CARL12A0581      |    |             |
|      |        | 350  | 240 | 30                     | CARL06J0546      |      |        | 2000 | 240 | 89                     | CARL12A0582      |    |             |
|      |        | 500  | 240 | 43                     | CARL06J0547      | 5/8  | 13     | 850  | 240 | 35                     | CARL13A0583      |    |             |
|      |        | 600  | 240 | 52                     | CARL06J0548      |      |        | 1500 | 240 | 59                     | CARL13A0584      |    |             |
|      |        | 900  | 240 | 78                     | CARL06J0549      | 5/8  | 14     | 900  | 240 | 34                     | CARL14A0585      |    |             |
| 5/8  | 6 3/4  | 500  | 240 | 40                     | CARL06N0550      |      |        | 1500 | 240 | 59                     | CARL14A0586      |    |             |
|      |        | 1000 | 240 | 81                     | CARL06N0551      |      |        | 3700 | 240 | 138                    | CARL14A0587      |    |             |
| 5/8  | 7      | 1000 | 240 | 85                     | CARL07A0552      | 5/8  | 15     | 600  | 240 | 21                     | CARL15A0588      |    |             |
|      |        | 1500 | 240 | 117                    | CARL07A0553      |      |        | 975  | 240 | 35                     | CARL15A0589      |    |             |
| 5/8  | 7 3/4  | 400  | 240 | 28                     | CARL07N0554      |      |        | 2400 | 240 | 85                     | CARL15A0590      |    |             |
|      |        | 500  | 240 | 35                     | CARL07N0555      |      |        | 4000 | 240 | 140                    | CARL15A0591      |    |             |
|      |        | 1000 | 240 | 70                     | CARL07N0556      | 5/8  | 16     | 1050 | 240 | 35                     | CARL16A0592      |    |             |
|      |        | 1500 | 240 | 105                    | CARL07N0557      |      |        | 4500 | 240 | 145                    | CARL16A0593      |    |             |
| 5/8  | 8      | 500  | 240 | 35                     | CARL08A0558      | 5/8  | 17     | 1000 | 240 | 32                     | CARL17A0594      |    |             |
|      |        | 850  | 240 | 62                     | CARL08A0559      |      |        | 5/8  | 18  | 1500                   | 240              | 43 | CARL18A0595 |
|      |        | 1000 | 240 | 69                     | CARL08A0560      | 2000 | 240    |      |     | 60                     | CARL18A0596      |    |             |
|      |        | 1000 | 240 | 69                     | CARL08A0561      |      |        |      |     |                        |                  |    |             |



ASB Heating Elements Ltd.

# Cartridge Heaters

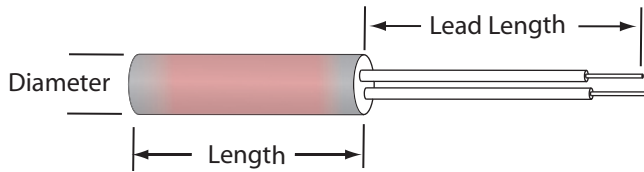

Figure 280

| Dia. | Length | W    | V   | Watts /in <sup>2</sup> | Catalogue Number |
|------|--------|------|-----|------------------------|------------------|
|      | 18     | 4700 | 240 | 135                    | CARL18A0597      |
| 5/8  | 20     | 1000 | 240 | 27                     | CARL20A0598      |
|      | 20     | 2500 | 240 | 66                     | CARL20A0599      |
|      | 20     | 4700 | 240 | 122                    | CARL20A0600      |
|      | 22     | 1000 | 240 | 25                     | CARL22A0601      |
| 3/4  | 3      | 500  | 240 | 85                     | CARN03A0602      |
| 3/4  | 3 3/4  | 500  | 240 | 65                     | CARN03N0603      |
|      | 3 3/4  | 1000 | 240 | 131                    | CARN03N0604      |
| 3/4  | 4      | 300  | 240 | 38                     | CARN04A0605      |
|      | 4      | 525  | 240 | 66                     | CARN04A0606      |
|      | 4      | 525  | 240 | 66                     | CARN04A0607      |
|      | 4      | 1000 | 240 | 122                    | CARN04A0608      |
| 3/4  | 4 1/2  | 350  | 120 | 42                     | CARN04J0609      |
| 3/4  | 4 3/4  | 750  | 240 | 75                     | CARN04N0610      |
| 3/4  | 5      | 500  | 240 | 49                     | CARN05A0611      |
|      | 5      | 500  | 240 | 49                     | CARN05A0612      |
|      | 5      | 700  | 240 | 68                     | CARN05A0613      |
|      | 5      | 1000 | 240 | 95                     | CARN05A0614      |
|      | 5 3/4  | 1000 | 240 | 81                     | CARN05N0615      |
| 3/4  | 5 3/4  | 1100 | 240 | 89                     | CARN05N0616      |
| 3/4  | 6      | 350  | 120 | 28                     | CARN06A0617      |
|      | 6      | 350  | 240 | 28                     | CARN06A0618      |
|      | 6      | 500  | 240 | 39                     | CARN06A0619      |
|      | 6      | 750  | 240 | 59                     | CARN06A0620      |
|      | 6      | 1100 | 240 | 87                     | CARN06A0621      |
|      | 6      | 1500 | 240 | 115                    | CARN06A0622      |
| 3/4  | 7      | 500  | 240 | 33                     | CARN07A0623      |
|      | 7      | 1000 | 240 | 65                     | CARN07A0624      |
| 3/4  | 7 1/2  | 450  | 120 | 32                     | CARN07J0625      |
| 3/4  | 7 3/4  | 1350 | 240 | 79                     | CARN07N0626      |
| 3/4  | 8      | 350  | 240 | 20                     | CARN08A0627      |
|      | 8      | 500  | 240 | 28                     | CARN08A0628      |

| Dia. | Length | W    | V    | Watts /in <sup>2</sup> | Catalogue Number |             |
|------|--------|------|------|------------------------|------------------|-------------|
| 8    | 8      | 600  | 240  | 36                     | CARN08A0629      |             |
|      | 8      | 700  | 240  | 40                     | CARN08A0630      |             |
|      | 8      | 1000 | 240  | 68                     | CARN08A0631      |             |
|      | 8      | 1350 | 240  | 78                     | CARN08A0632      |             |
|      | 8      | 2000 | 240  | 115                    | CARN08A0633      |             |
| 3/4  | 9      | 2000 | 240  | 101                    | CARN09A0634      |             |
| 3/4  | 9 3/4  | 2000 | 240  | 92                     | CARN09N0635      |             |
| 3/4  | 10     | 600  | 240  | 27                     | CARN10A0636      |             |
|      | 10     | 800  | 240  | 36                     | CARN10A0637      |             |
|      | 10     | 800  | 240  | 36                     | CARN10A0638      |             |
|      | 10     | 1000 | 240  | 46                     | CARN10A0639      |             |
|      | 10     | 1200 | 240  | 54                     | CARN10A0640      |             |
|      | 10     | 2000 | 240  | 49                     | CARN10A0641      |             |
| 3/4  | 11 3/4 | 1000 | 240  | 37                     | CARN11N0642      |             |
|      | 11 3/4 | 1500 | 240  | 56                     | CARN11N0643      |             |
|      | 11 3/4 | 2000 | 240  | 75                     | CARN11N0644      |             |
| 3/4  | 12     | 600  | 240  | 46                     | CARN12A0645      |             |
|      | 12     | 800  | 240  | 54                     | CARN12A0646      |             |
|      | 12     | 950  | 240  | 49                     | CARN12A0647      |             |
|      | 12     | 1500 | 240  | 56                     | CARN12A0648      |             |
|      | 12     | 2000 | 240  | 75                     | CARN12A0649      |             |
| 3/4  | 13     | 1000 | 240  | 34                     | CARN13A0650      |             |
|      | 3/4    | 14   | 1100 | 240                    | 35               | CARN14A0651 |
|      |        | 14   | 1400 | 240                    | 45               | CARN14A0652 |
| 14   |        | 2500 | 240  | 78                     | CARN14A0653      |             |
| 3/4  | 14 3/4 | 1500 | 240  | 44                     | CARN14N0654      |             |
| 3/4  | 16     | 1000 | 240  | 28                     | CARN16A0655      |             |
|      | 16     | 1250 | 240  | 35                     | CARN16A0656      |             |
|      | 16     | 1500 | 240  | 44                     | CARN10A0657      |             |
|      | 16     | 1800 | 240  | 49                     | CARN16A0658      |             |
| 3/4  | 18     | 1450 | 240  | 35                     | CARN18A0659      |             |
|      | 18     | 2000 | 240  | 49                     | CARN18A0660      |             |
| 3/4  | 20     | 2200 | 240  | 48                     | CARN20A0661      |             |
| 3/4  | 24     | 1950 | 240  | 35                     | CARN24A0662      |             |
|      | 24     | 2750 | 240  | 50                     | CARN24A0663      |             |